

Separation by Chromatography

Lecture VAK 02-6007

May 04, 2004

Johannes Ranke

1D Separation methods

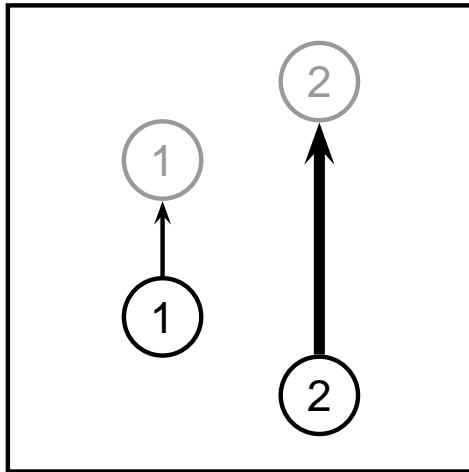

Electrophoresis

1D Separation methods

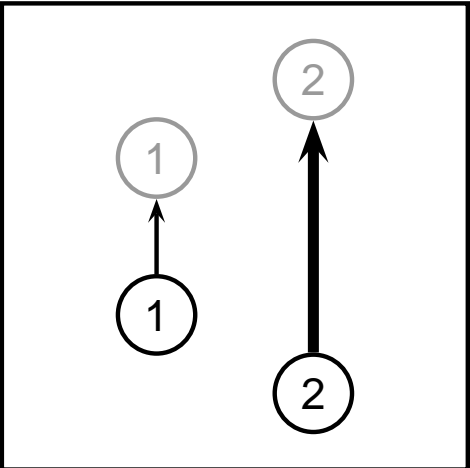

Electrophoresis

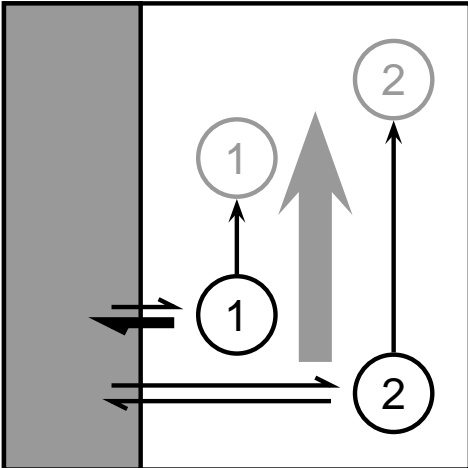

Chromatography

1D Separation methods

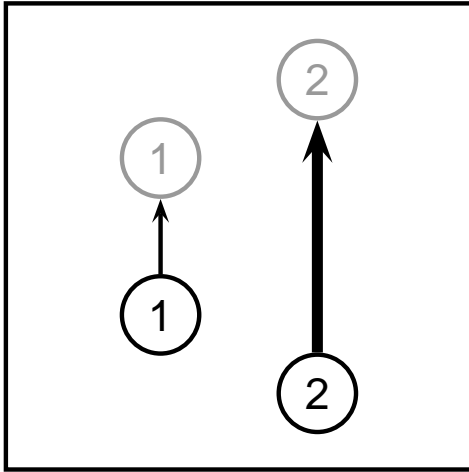

Electrophoresis

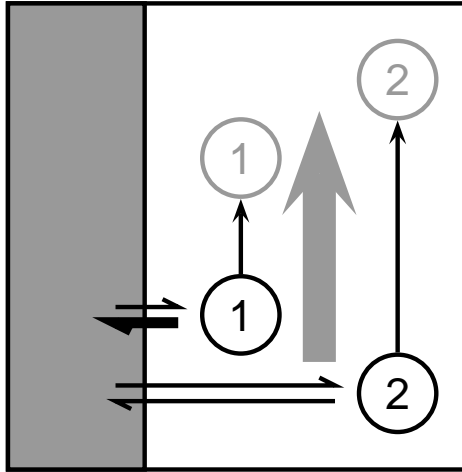

Chromatography

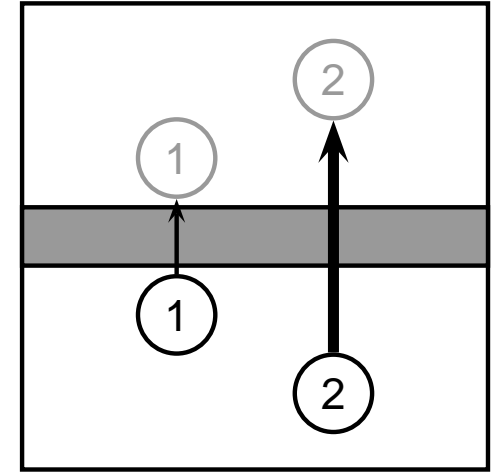

Membrane separation

1D Separation methods

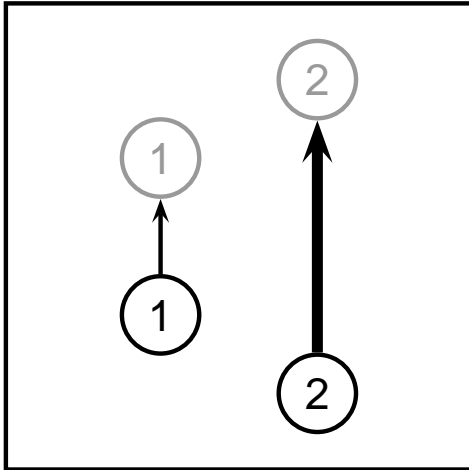

Electrophoresis

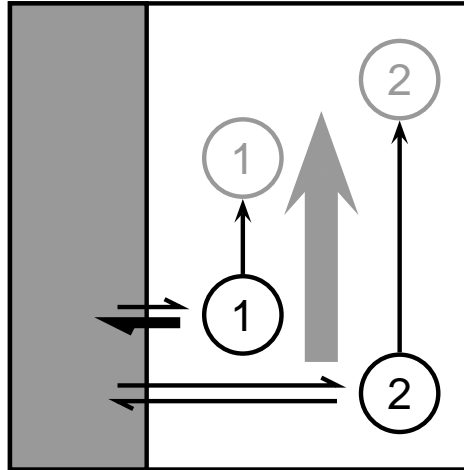

Chromatography

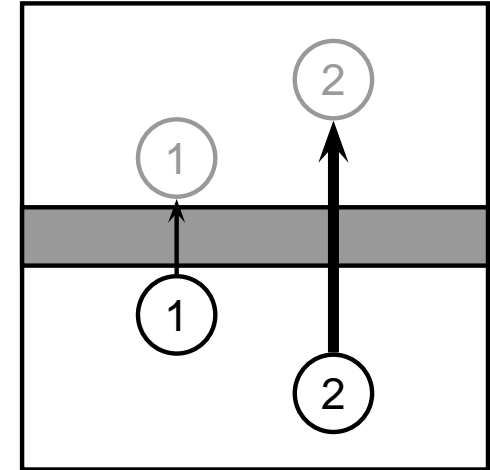

Membrane separation

Separation according to

- Kinetic properties
- Equilibrium distribution
- Combinations thereof

Elution techniques

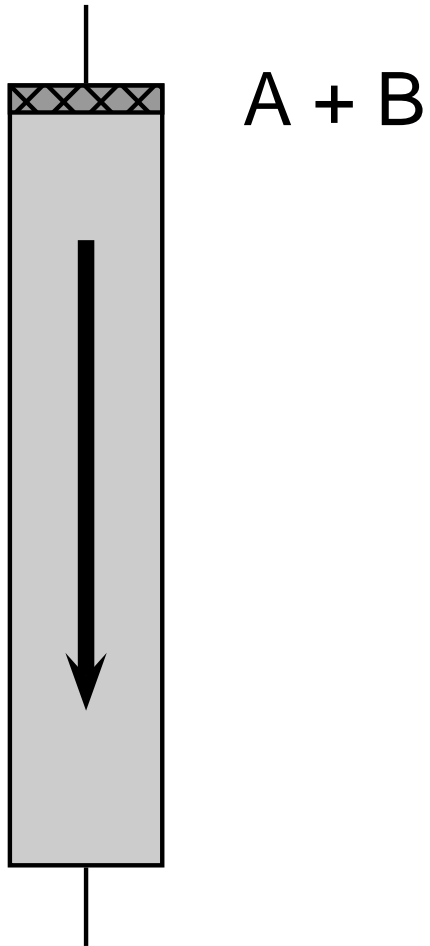

Elution techniques

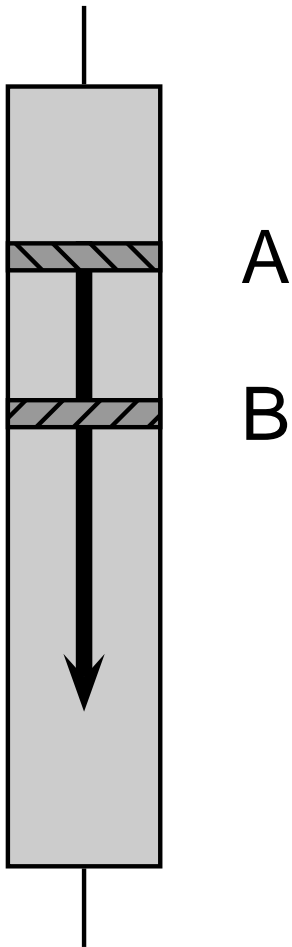

Elution techniques

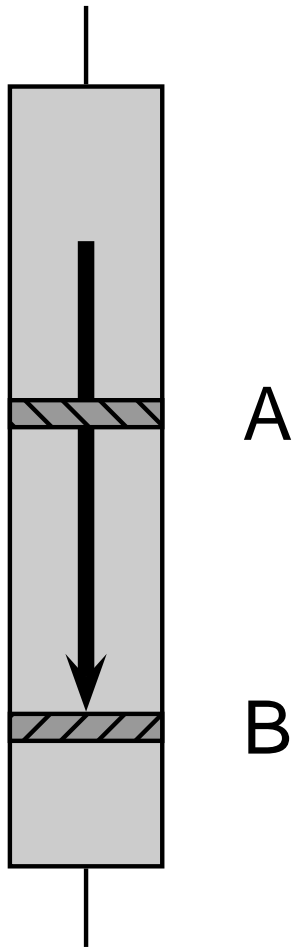

Elution techniques

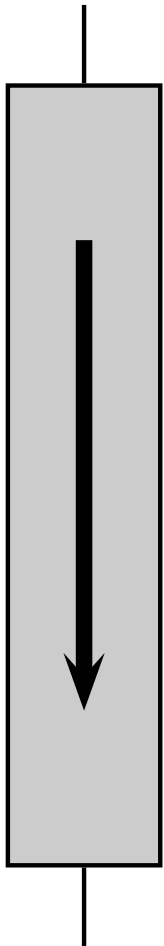

Detector signal

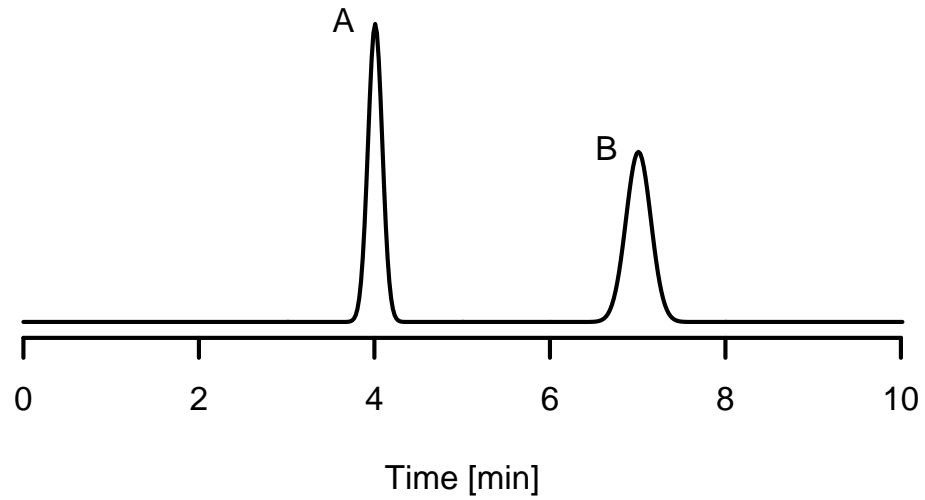

Equilibrium based separation

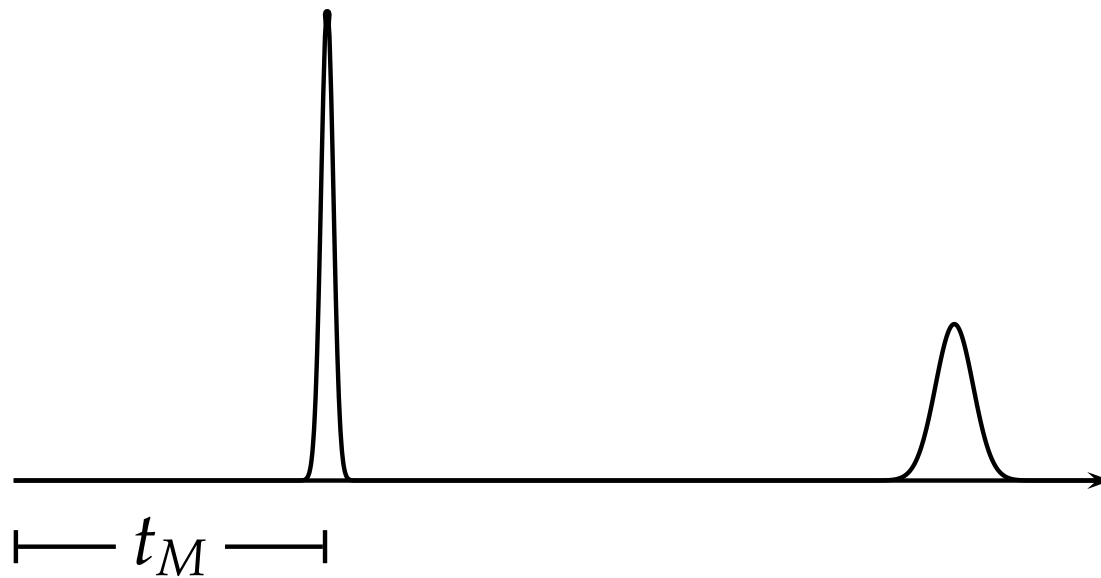

Equilibrium based separation

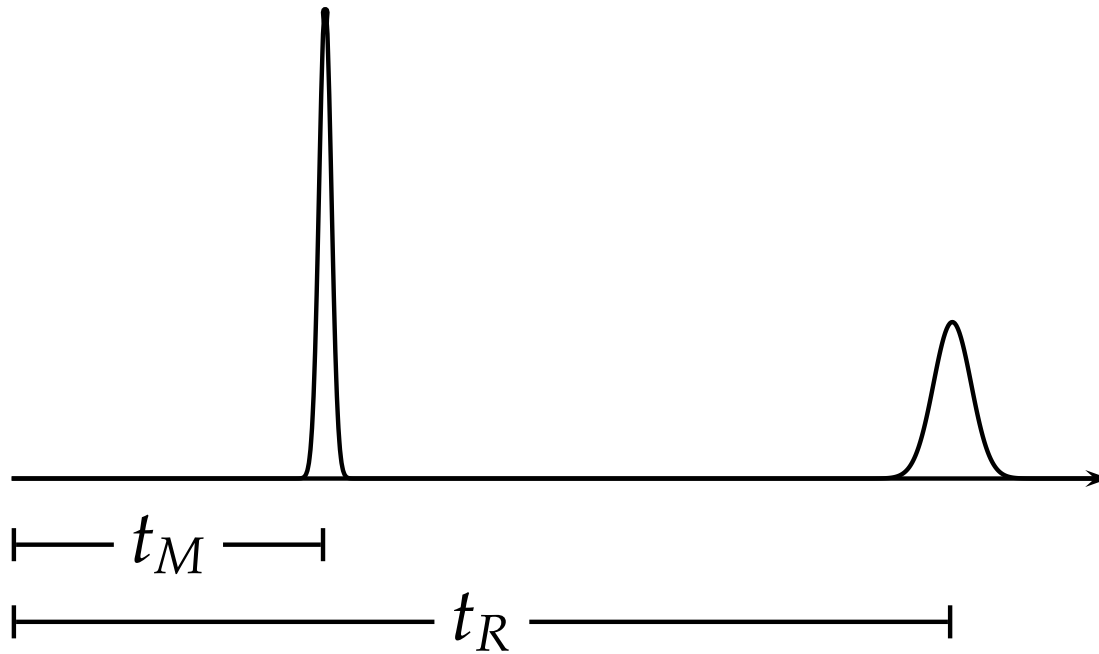

Equilibrium based separation

$$k' = \frac{n_S}{n_M}$$

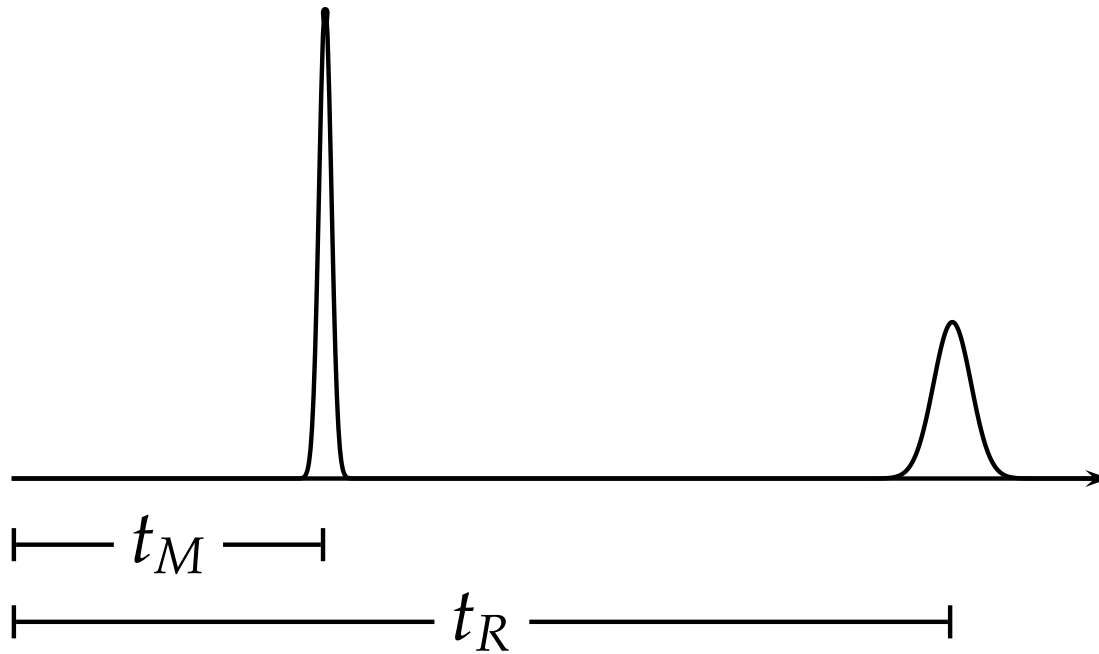

Equilibrium based separation

$$k' = \frac{n_S}{n_M} = \frac{\bar{t}_S}{\bar{t}_M}$$

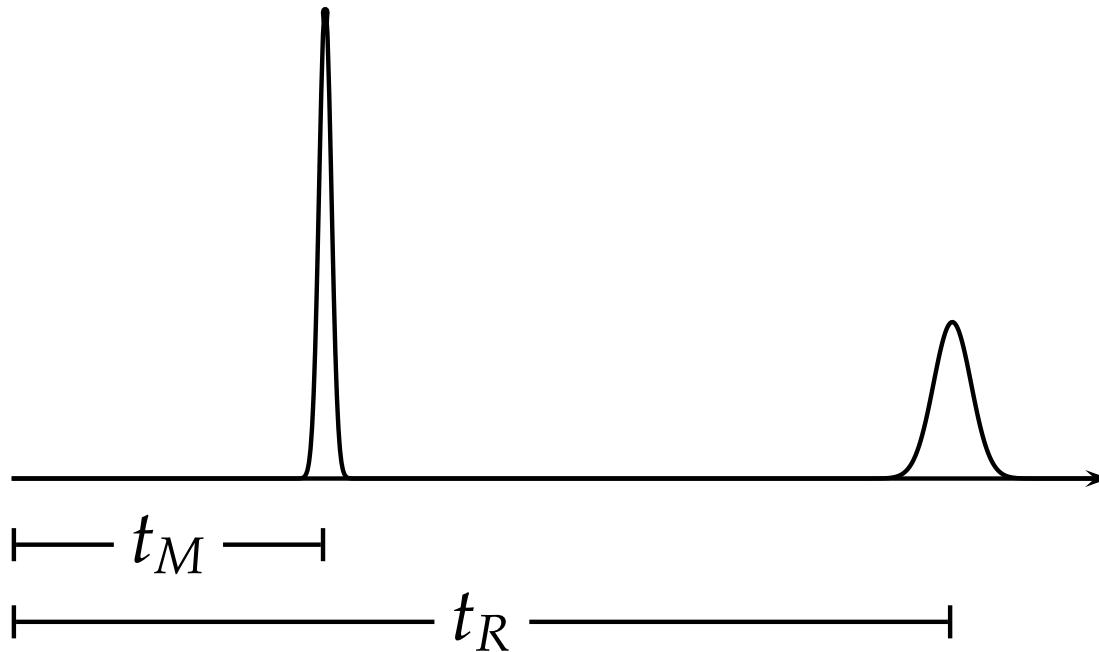

Equilibrium based separation

$$k' = \frac{n_S}{n_M} = \frac{\bar{t}_S}{\bar{t}_M} = \frac{t_R - t_M}{t_M}$$

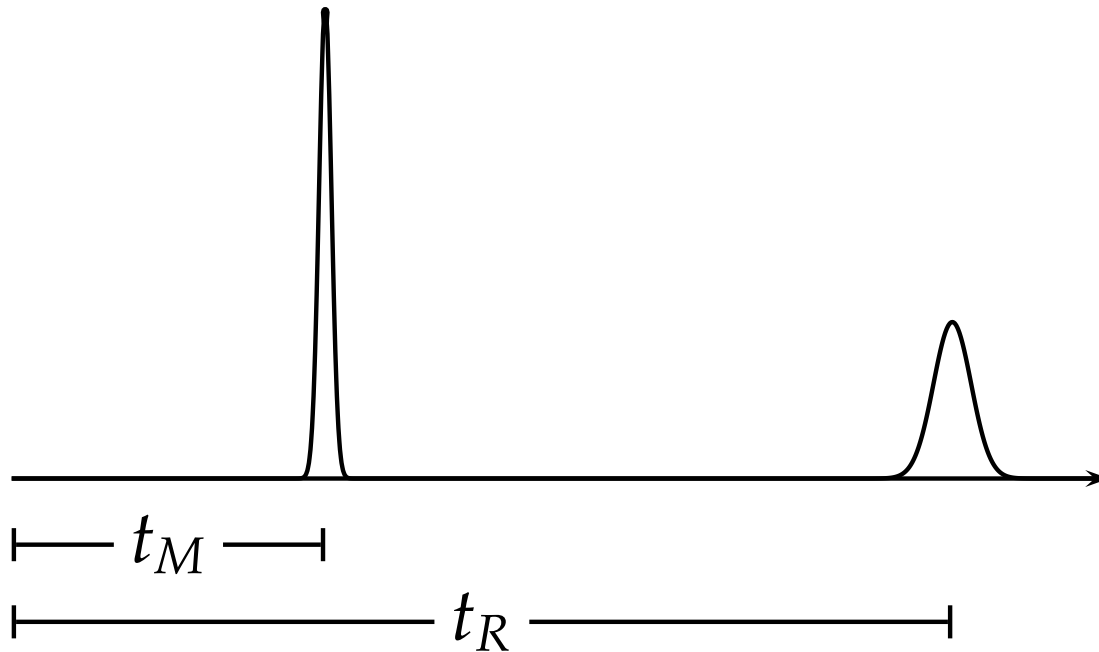

Equilibrium based separation

$$k' = \frac{n_S}{n_M} = \frac{\bar{t}_S}{\bar{t}_M} = \frac{t_R - t_M}{t_M}$$

$$k' = \frac{c_S \cdot V_S}{c_M \cdot V_M}$$

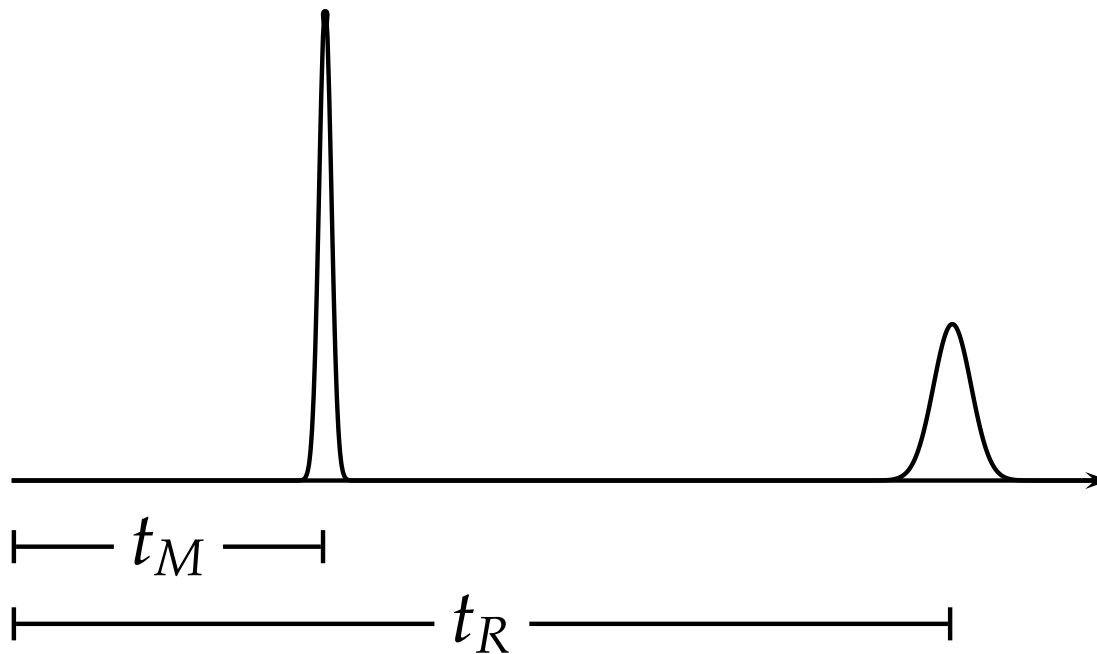

Equilibrium based separation

$$k' = \frac{n_S}{n_M} = \frac{\bar{t}_S}{\bar{t}_M} = \frac{t_R - t_M}{t_M}$$

$$k' = \frac{c_S \cdot V_S}{c_M \cdot V_M} = K \cdot \frac{V_S}{V_M}$$

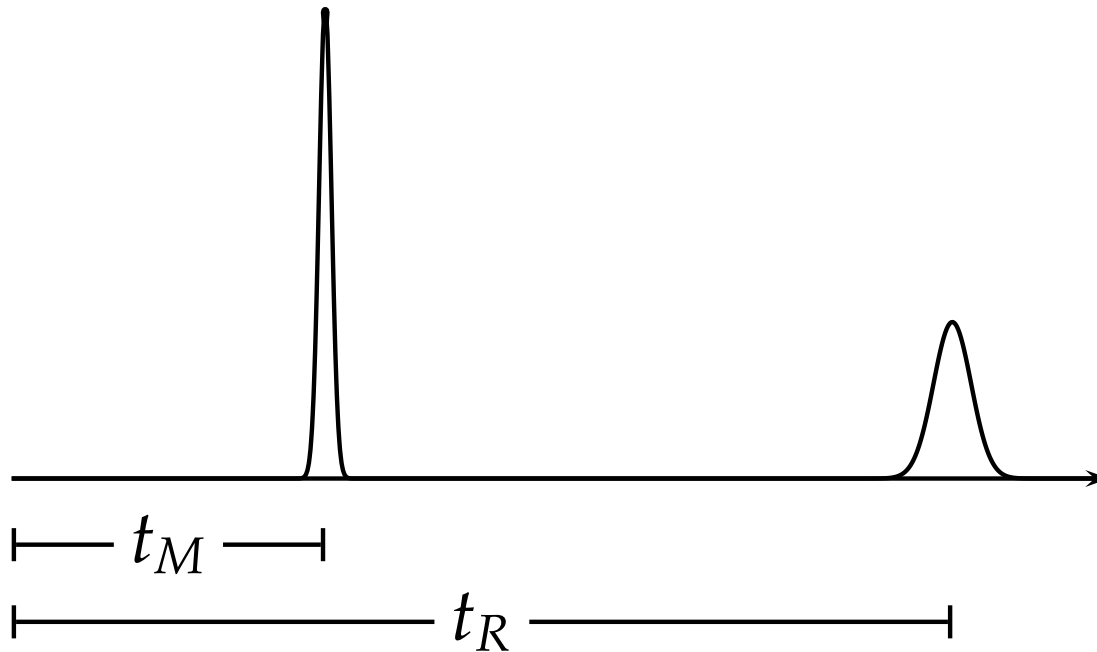

Equilibrium based separation

$$t_M = F \cdot V_M$$

$$t_R = F \cdot V_R$$

$$k' = \frac{n_S}{n_M} = \frac{\bar{t}_S}{\bar{t}_M} = \frac{t_R - t_M}{t_M} = \frac{V_R - V_M}{V_M}$$

$$k' = \frac{c_S \cdot V_S}{c_M \cdot V_M} = K \cdot \frac{V_S}{V_M}$$

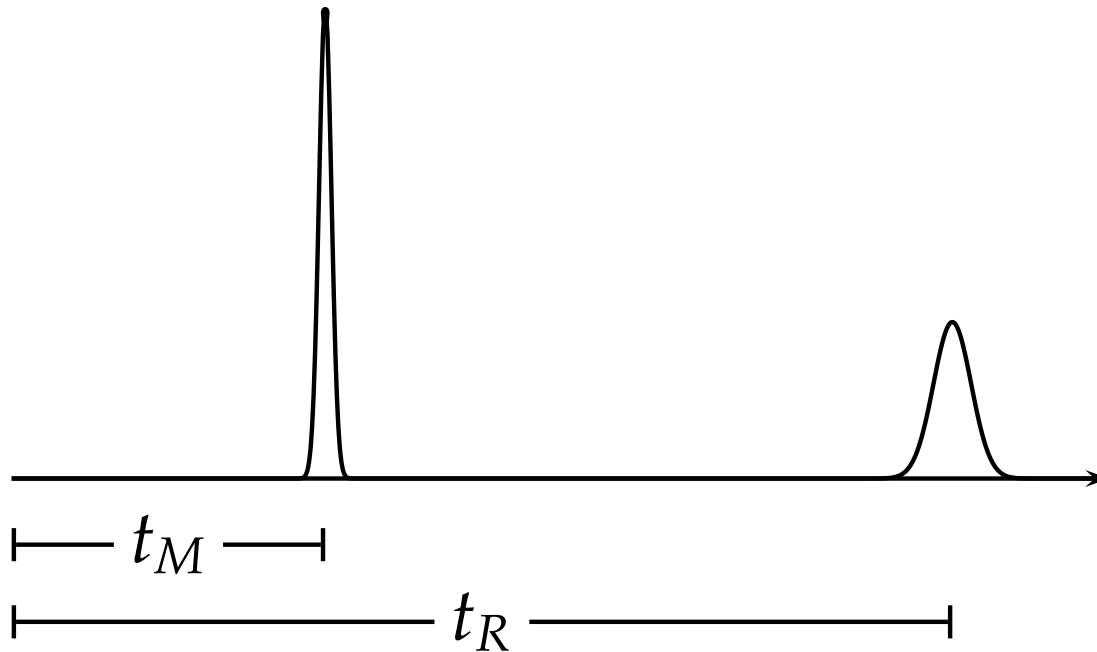

Equilibrium based separation

$$t_M = F \cdot V_M$$

$$t_R = F \cdot V_R$$

$$k' = \frac{n_S}{n_M} = \frac{\bar{t}_S}{\bar{t}_M} = \frac{t_R - t_M}{t_M} = \frac{V_R - V_M}{V_M}$$

$$k' = \frac{c_S \cdot V_S}{c_M \cdot V_M} = K \cdot \frac{V_S}{V_M}$$

$$V_R \approx V_M + K \cdot V_S$$

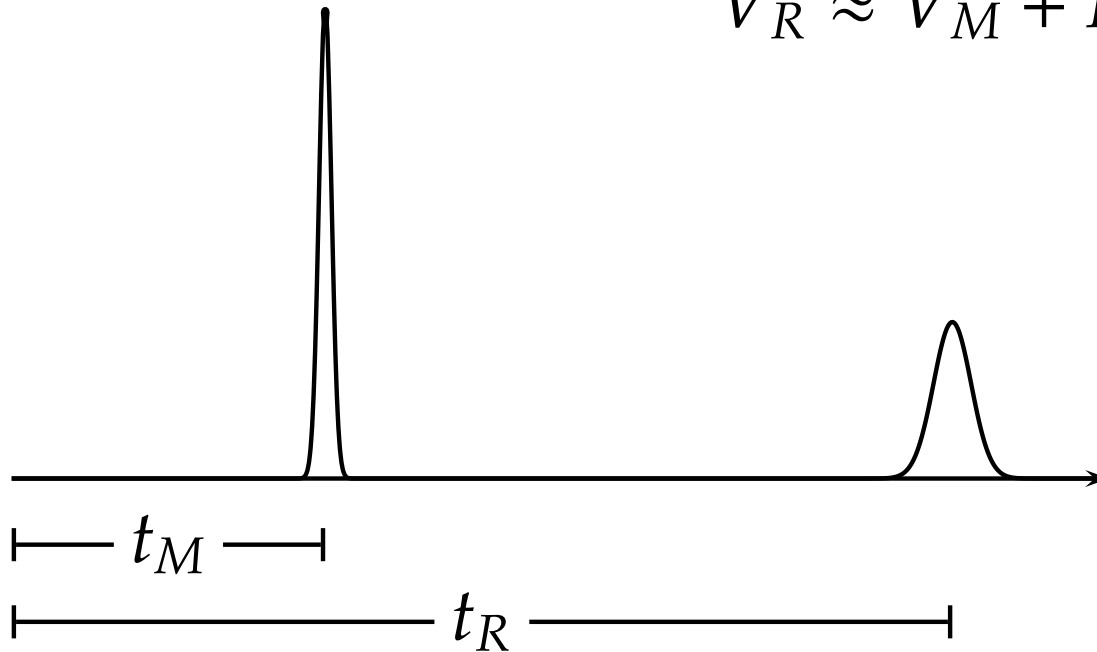

Equilibrium constant

$$K_i = \exp(-\Delta G_i^0 / RT) = \exp\left(-\frac{\Delta H_i^0 - T\Delta S_i^0}{RT}\right)$$

Equilibrium constant

$$K_i = \exp(-\Delta G_i^0/RT) = \exp\left(-\frac{\Delta H_i^0 - T\Delta S_i^0}{RT}\right)$$

If $\Delta H_i^0 \approx 0$, then

$$K_i \approx \exp(-\Delta S_i^0/R),$$

i.e. K_i is independent from temperature.

Peak shapes

Isotherm

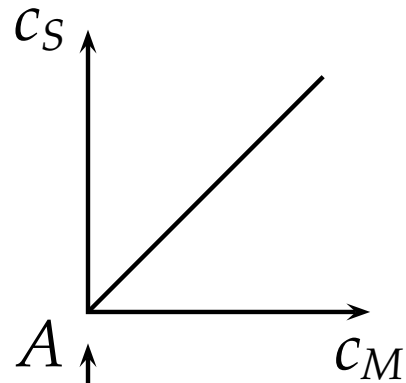

Signal shape

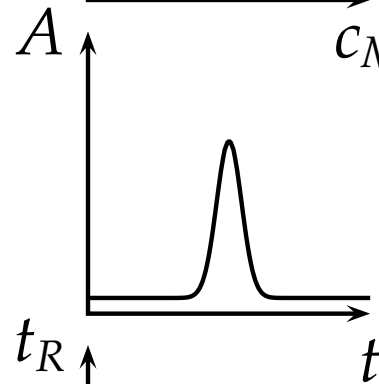

Retention time

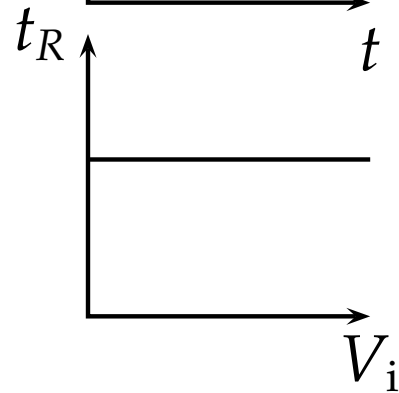

Peak shapes

Isotherm

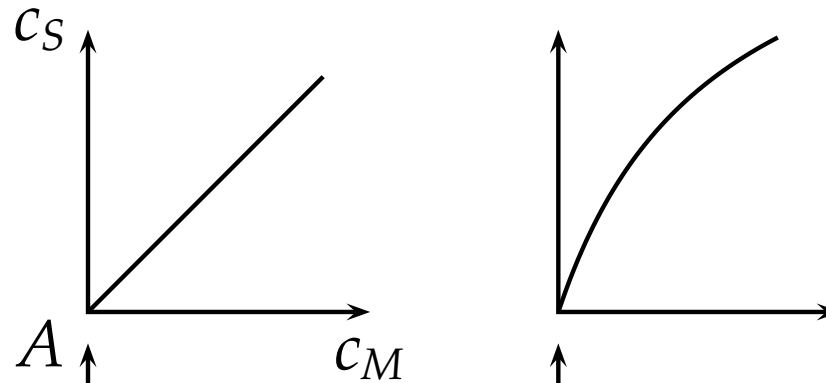

Signal shape

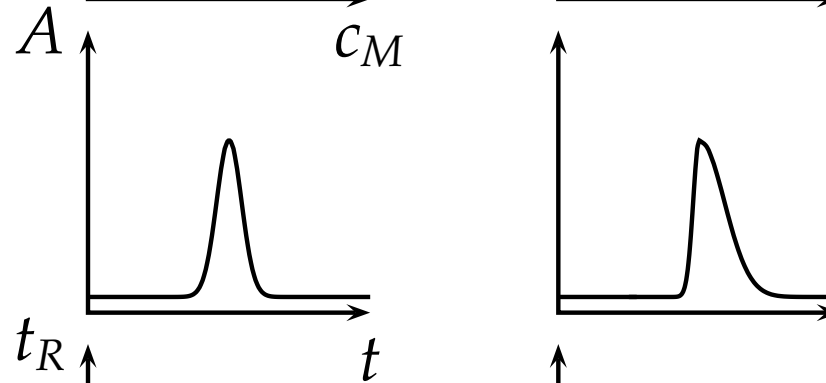

Retention time

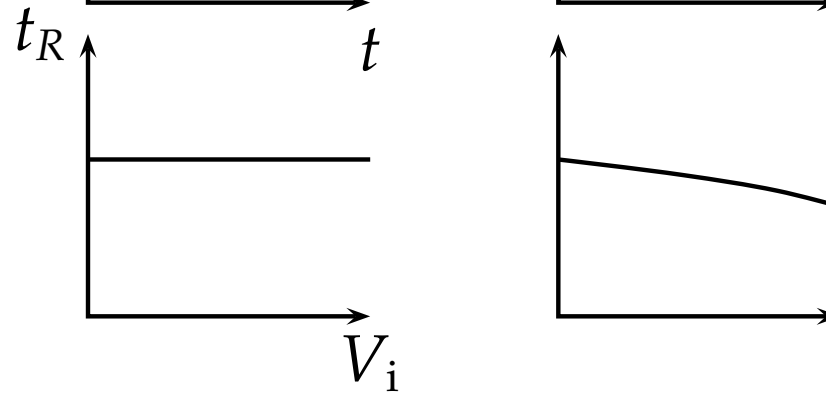

Peak shapes

Isotherm

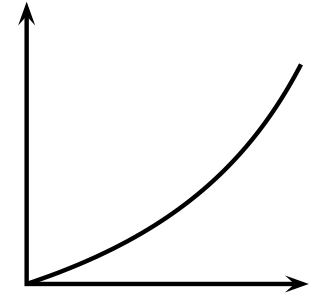
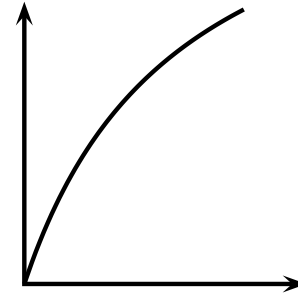
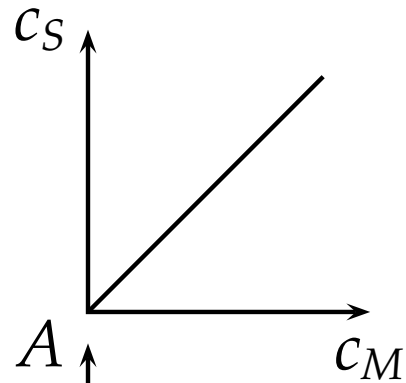

Signal shape

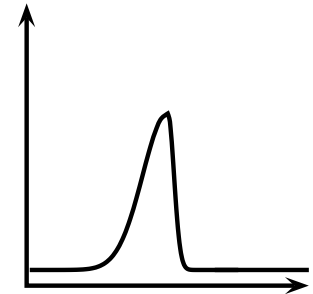
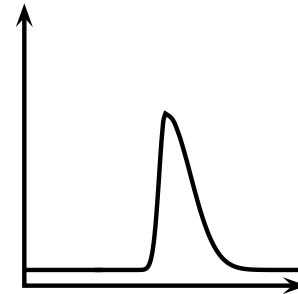
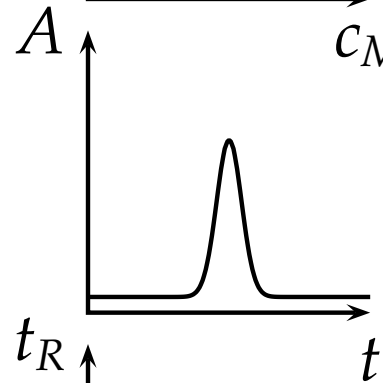

Retention time

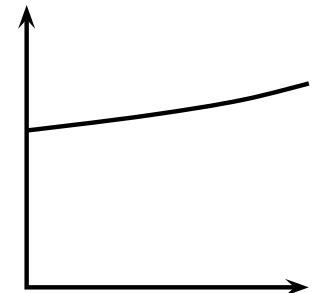
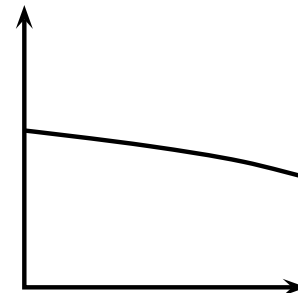
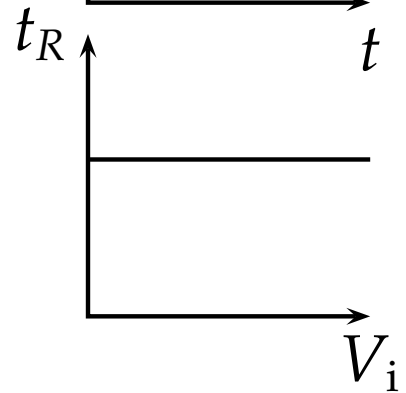

Column performance

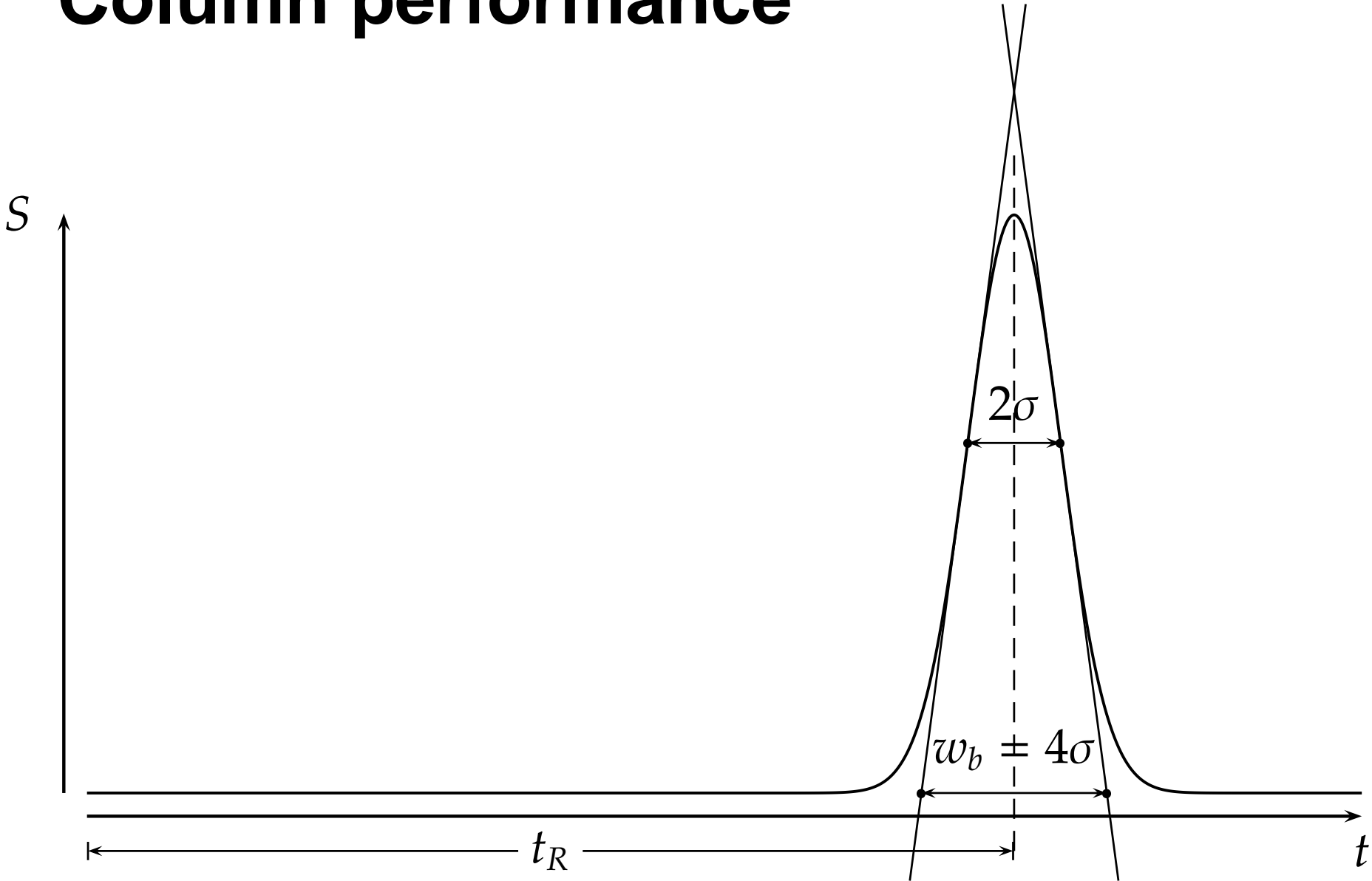

Column performance

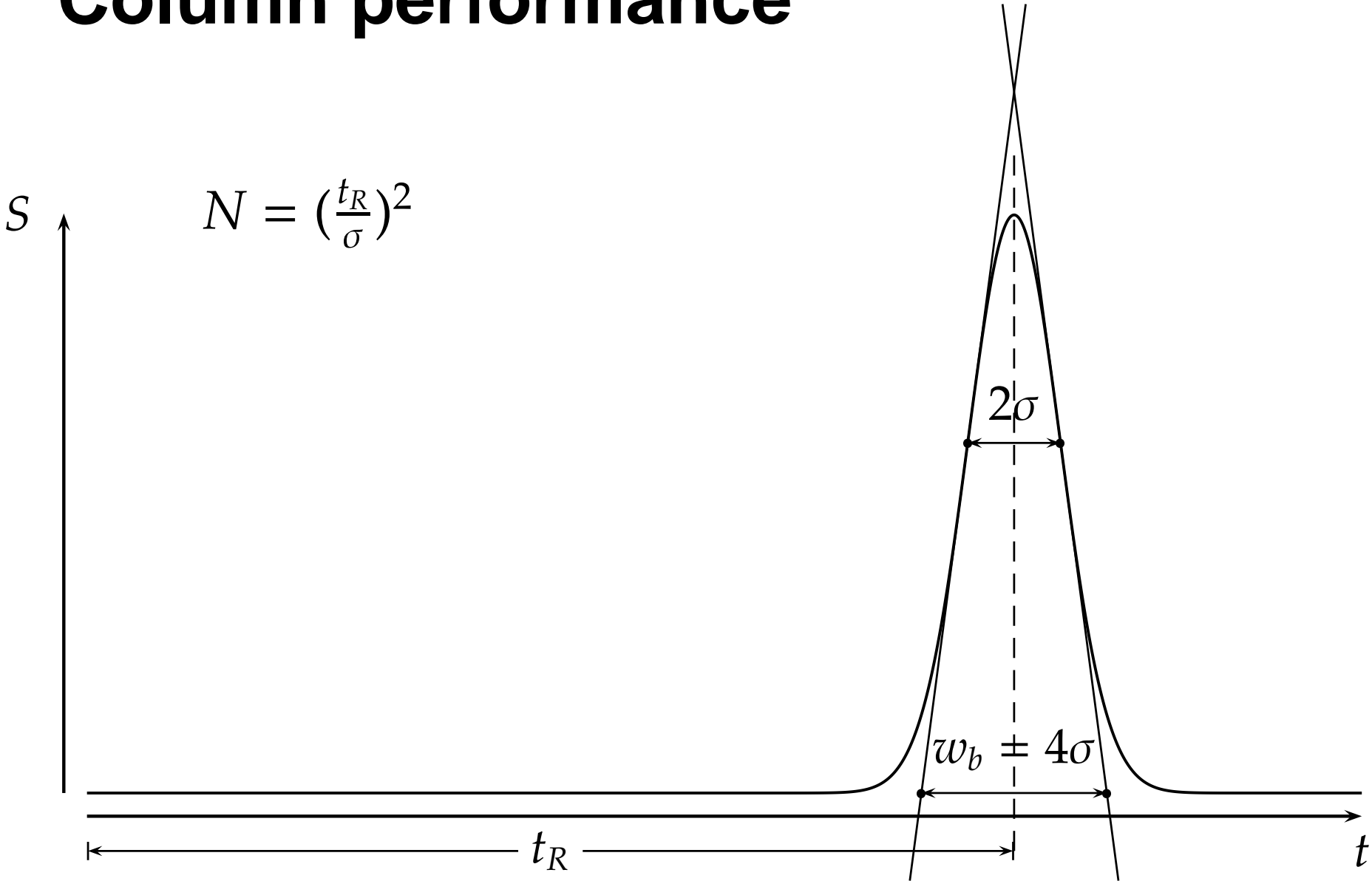

Column performance

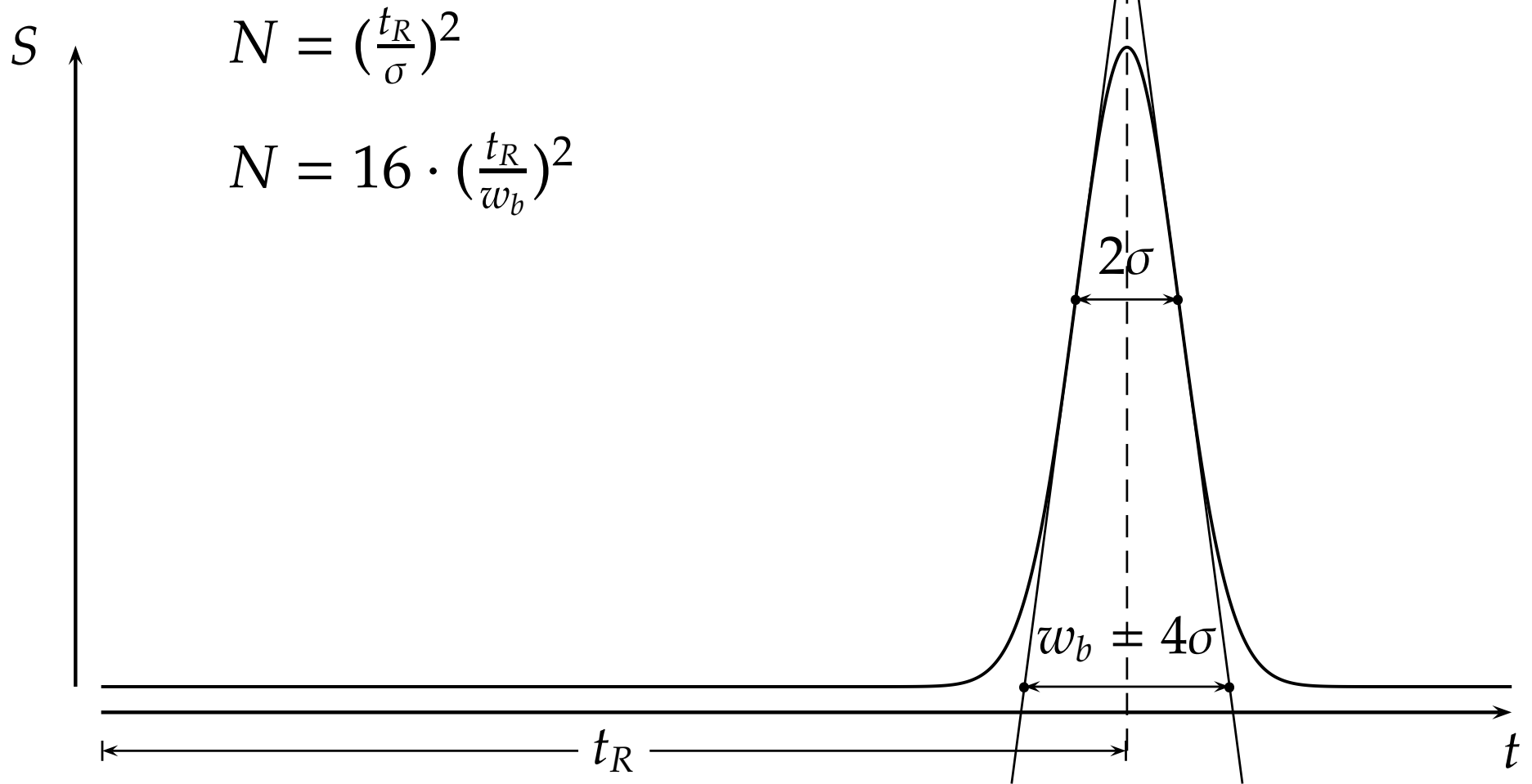

$$N = \left(\frac{t_R}{\sigma}\right)^2$$

$$N = 16 \cdot \left(\frac{t_R}{w_b}\right)^2$$

Column performance

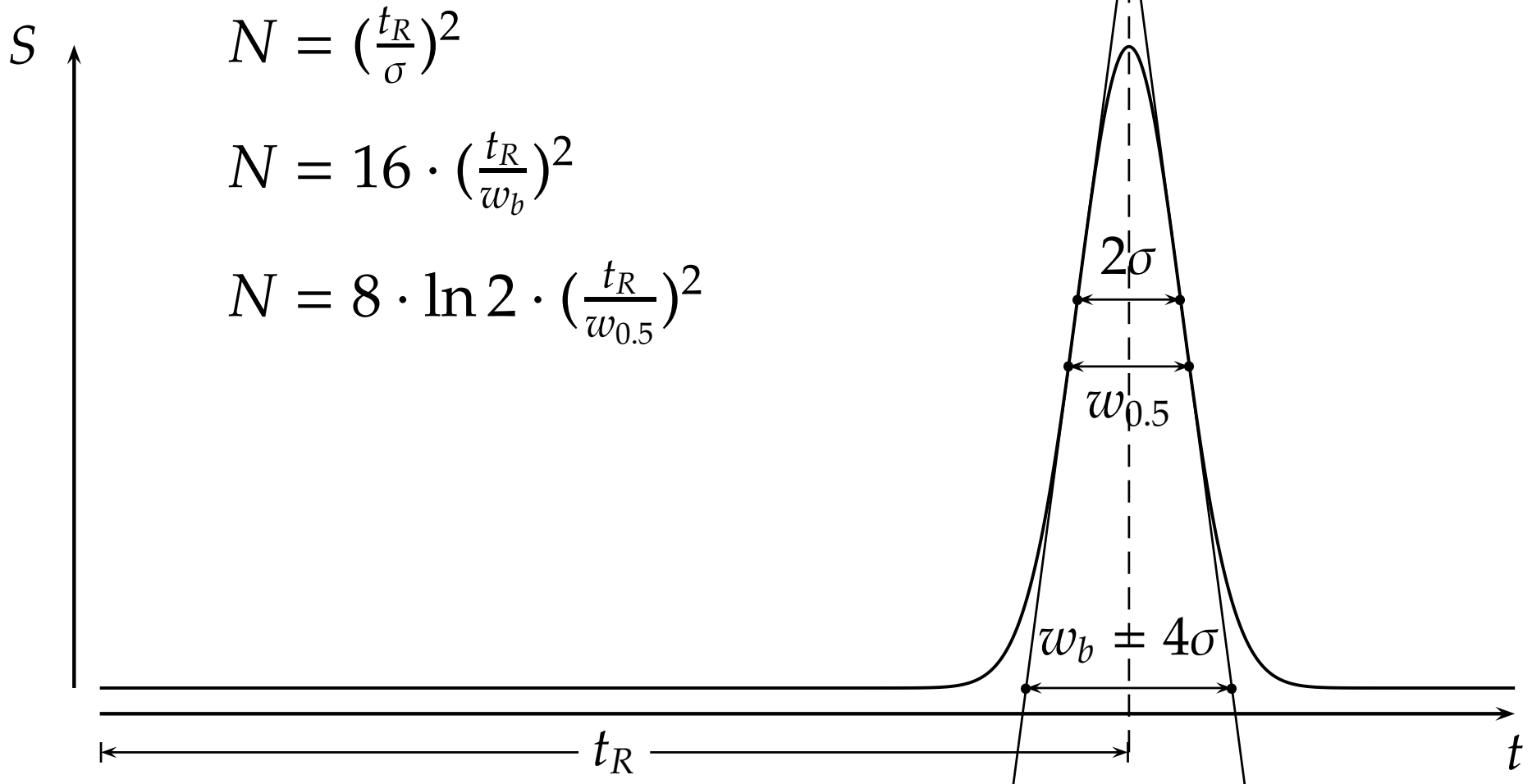

Column performance

$$N = 16 \cdot \left(\frac{t_R}{w_b}\right)^2$$

Column performance

$$N = 16 \cdot \left(\frac{t_R}{w_b}\right)^2$$

$$N_{\text{eff}} = 16 \cdot \left(\frac{t_R - t_0}{w_b}\right)^2$$

Column performance

$$N = 16 \cdot \left(\frac{t_R}{w_b}\right)^2$$

$$N_{\text{eff}} = 16 \cdot \left(\frac{t_R - t_0}{w_b}\right)^2$$

$$H = \frac{L}{N}$$

H is the Height Equivalent of a Theoretical Plate (HETP).

Column performance

	H [mm]	\dot{N} [s ⁻¹]	n_{sample}
TLC	0.7	1	$\mu\text{g} - \text{mg}$
HPTLC	0.02	50	20 ng - mg
Column	20	0.0005	mg - kg
HPLC	0.01	400	ng - mg
packed GC	0.5	100	$\mu\text{g} - \text{g}$
capillary GC	0.25	400	pg - μg

Column performance

$$\text{Resolution } R_S = \frac{t_{R,1} - t_{R,2}}{0.5 \cdot (w_{b,1} + w_{b,2})}$$

Column performance

$$\text{Resolution } R_S = \frac{t_{R,1} - t_{R,2}}{0.5 \cdot (w_{b,1} + w_{b,2})}$$

$$\text{Separation factor } \alpha = \frac{k'_2}{k'_1} = \frac{t_{R,2} - t_0}{t_{R,1} - t_0} = \frac{K_2}{K_1}$$

Column performance

$$\text{Resolution } R_S = \frac{t_{R,1} - t_{R,2}}{0.5 \cdot (w_{b,1} + w_{b,2})}$$

$$\text{Separation factor } \alpha = \frac{k'_2}{k'_1} = \frac{t_{R,2} - t_0}{t_{R,1} - t_0} = \frac{K_2}{K_1}$$

$$R_S = \frac{\sqrt{N_{\text{eff}}}}{4} \frac{\alpha - 1}{\alpha}$$

Peak dispersion

- Injection

Peak dispersion

- Injection
- Dispersion in capillaries

Peak dispersion

- Injection
- Dispersion in capillaries
- **Dispersion in columns**

Peak dispersion

- Injection
- Dispersion in capillaries
- **Dispersion in columns**
- Dispersion caused by signal detection

Dispersion in columns

van-Deemter equation:

$$H = A + B/v + Cv$$

- Eddy diffusion

$$A = 2\lambda d_R$$

Dispersion in columns

van-Deemter equation:

$$H = A + B/v + Cv$$

- Eddy diffusion
 $A = 2\lambda d_R$
- Longitudinal diffusion
 $B = 2\Psi D_M$

Dispersion in columns

van-Deemter equation:

$$H = A + B/v + Cv$$

- Eddy diffusion

$$A = 2\lambda d_R$$

- Longitudinal diffusion

$$B = 2\Psi D_M$$

- Lateral diffusion, disequilibrium

$$C = K_1 \cdot R \cdot (1 - R) \cdot d_f^2 / D_S + K_2 / D_M$$

Dispersion in columns

van-Deemter equation:

$$H = A + B/v + Cv$$

- Eddy diffusion

$$A = 2\lambda d_R$$

- Longitudinal diffusion

$$B = 2\Psi D_M$$

- Lateral diffusion, disequilibrium

$$C = K_1 \cdot R \cdot (1 - R) \cdot d_f^2 / D_S + K_2 / D_M$$